

LOW VOLTAGE AC DRIVES

ABB general purpose drives

ACS480, 0.75 to 11 kW



—
**Pure easiness for
your application.
ACS480 series.**

Table of contents

004	The all-compatible ACS480 series
006	Simplicity at the core of your application
008	Standard ACS480 drive software with versatile features
010	How to select a drive
011	Ratings, types and voltages
012	Technical data
012	Dimensions
013	Easiness on a whole new level
014	Control panel options and mounting kits
016	Standard interface and extensions for plug-in connectivity
017	Options and tools
018	Cooling and fuses
019	Input chokes, du/dt filters, brake choppers and resistors
021	Everything for your application
022	Save time, ease troubleshooting and improve drive performance with ABB smartphone apps
023	A lifetime of peak performance

The all-compatible ACS480 series

Pure easiness for your application

Some applications need only the essentials from their drives: efficiency and simplicity in a small package, delivered as effortlessly as possible. The ACS480 general purpose drive is exactly that: it brings all the essentials effortlessly together for you to run basic speed-controlled applications.

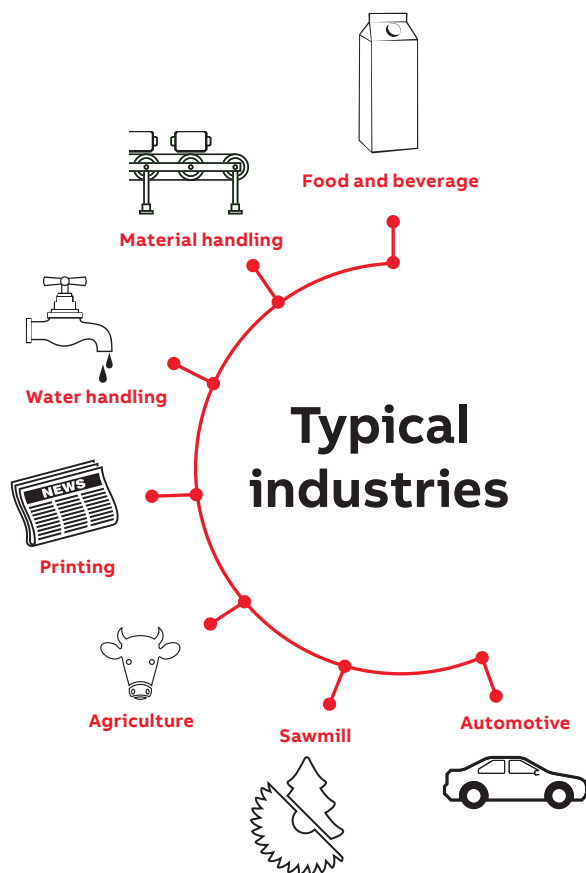

Pure easiness for many applications

All the essential features are built-in, which makes the drive suitable for a broad range of applications by simplifying drive selection and reducing the need for additional hardware. The user-friendly, functionality-focused menu with 13 different languages on the ACS480 control panel provides smart and quick commissioning and startup of the drive. Users can also upgrade the panel to an optimal Bluetooth control panel for wireless commissioning and monitoring. Primary settings and integrated macros are designed to make setting parameters and commissioning as simple as possible with only a few clicks.

Scalable offering

What if you require even more flexibility? You can choose the next member of the all-compatible drives portfolio, such as the ACS580 general purpose drive, or for even more demanding applications, the ACS880 is there to help you. These drives share the same user interfaces and options, enabling you to use the knowledge you have gained with the ACS480 drives. You increasingly keep saving time, as it is not wasted on learning one new interface after another. And saving time in business means saving money and improving profit potential.

Instant availability

ACS480 products are available from central stocks around the world for immediate delivery up to 11 kW. The product is also widely available from ABB distributors.

Maximum reliability

Design features like coated circuit boards, minimized airflow through the control board section, earth fault protection and design for 50 °C ambient temperature make the ACS480 a safe choice.



Simplicity at the core of your application

The ACS480 general purpose drive is equipped with built-in features that simplify ordering and delivery, and reduce commissioning costs, since everything is provided in a single, compact and ready-to-use package.



Startup and maintenance tool

Drive composer PC tool for startup, configuration, monitoring and process tuning. The PC tool is connected to the drive's control panel via a USB interface.

Simple to select, install and use

Built-in features, such as an EMC filter, a Modbus RTU fieldbus interface and safe torque off functionality, simplify drive selection, installation and use.



Simplicity at your fingertips as standard

The control panel's straightforward primary settings menu with assistants help you set up and operate the drive quickly and effectively.

Easiness with built-in brake chopper

A brake chopper is built-in as standard for all the ACS480 drives. The brake chopper enables shorter and more accurate braking times, which instantly increases productivity.



Easiness with the built-in STO SIL 3 / PL e

STO protects both people and machines by preventing unexpected startup and stopping-related functions, enabling safe machine maintenance and operation.



The ACS480 general purpose drives are part of ABB's all-compatible drives portfolio. They ensure simplicity and essential energy efficiency throughout their whole life cycle. The ACS480 drive is ready to control many basic applications such as fans, compressors and conveyors.



Easiness with all major automation networks

Optional fieldbus adapters enable connectivity with all major industrial automation networks. A fieldbus enables communication between drives and PLC systems, I/O devices and the process while reducing wiring costs compared to traditional hardwired input/output connections.

Designed for maximum reliability

Design features like coated circuit boards, minimized airflow through the control board section, earth fault protection and design for 50 °C ambient temperature make the ACS480 a safe choice.

Easiness with the built-in EMC C2 filter

High-frequency noise can directly affect sensitive electronic equipment and high-speed communication fieldbuses. Each ACS480 drive is equipped with a built-in EMC filter to reduce high-frequency emissions. The built-in EMC C2 filter allows the drive to be used in industrial and commercial (building) environments without a need to buy and install any external filters.

Easiness with extensive I/O connections and built-in Modbus RTU

The ACS480 comes as standard with an I/O module that features extensive input and output connections for flexible configuration in various applications. In addition, the I/O module includes Modbus RTU interface that easily connects to the automation network. Colored terminals ensure easy configuration and minimize mistakes in wiring.

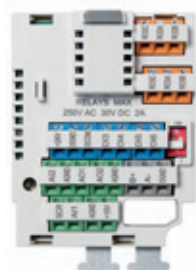

Standard ACS480 drive software with versatile features

Improve the performance of the motor and process with sophisticated process control in scalar and vector control modes. Scalar control is a good choice when simplicity is at the core, while vector control is especially for accurate and energy-efficient speed control in demanding applications.

Save commissioning and learning time with the assistant control panel's clear and intuitive user interface and different assistants.

Optimize energy efficiency with features that help you save and manage energy. You can monitor the hourly, daily and cumulative energy consumption via kWh counters. Support for high-efficiency induction, synchronous reluctance and permanent magnet motors enables even higher system efficiency.

Reduce motor noise by spreading the switching frequencies over a user-specified range.

Reduce costs with the built-in and standalone process PID. It makes the ACS480 a self-governing unit requiring only an external process measurement. No external logic input from the control room is needed.

Analyze and optimize the application with the load profile log, which shows you how the drive is operating. Monitor values that matter to you on multiple home view displays.

Control delicate loads with care with mechanical brake control. It prevents small movements of, for example, a belt conveyor while halted.

Save time with primary settings that enable quick access to the most commonly used parameters and settings without a need to go through the complete parameter list.

Analyze and resolve issues with the control panel's diagnostics menu. You can quickly analyze why the drive is performing as it is; running, stopped or running at the present speed.

Reduce manual work with functions that do it for you. The timing function switches between different setpoints based on a predefined schedule, the accel/decel ramps accelerate and decelerate the motor as you want, and the ready made PFC macro sets on and off parallel motors in order to ensure optimal output.

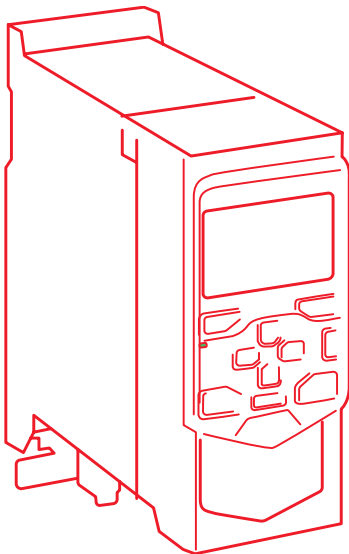

Typical applications

ACS480 drives improve process reliability, increase productivity and ensure machine and personnel safety

Industry	Application	Customer benefits
Food and beverage	Blowers, compressors, conveyors, fans, mills, pumps, dryers	<ul style="list-style-type: none"> • Accurate control of the process increases the speed of food production while saving energy and improving work safety. Precise speed control increases production uptime even when the load varies. • Increased starting torque with boost function allows the same drive series to be used in different applications in the manufacturing plant. • Safe torque off (SIL 3/PL e) function ensures machine and personnel safety. • The easy-to-use control panel with 13 different languages and robust design reduces the time needed for maintenance.
Material handling	Conveyors	<ul style="list-style-type: none"> • Accurate and precise speed control increases production uptime even when the load varies. • Safe torque off (SIL 3/PL e) function ensures machine and personnel safety. • Minimized downtime with robust and reliable design. • Integrated brake chopper enabling faster and more accurate start and stop cycles. • User load curve function monitors an input signal as a function of frequency or speed, and load, and gives a warning or fault if the curve does not stay within a user-defined profile.
Printing	Compressors, presses, winders	<ul style="list-style-type: none"> • Smooth acceleration to prevent breaking the paper. • The robust design of the drive reduces mechanical stress on process line equipment, lowering maintenance costs and capital expenditure. • Precise speed control of applications increases process uptime by optimizing motor control.
Textile	Bleaching machines, compressors, conveyors, fans, jet dyeing machines, pumps	<ul style="list-style-type: none"> • Precise speed control for high stretching accuracy and better quality of the end product. • Adjustable accel/decel ramps to improve pump control. • Real-time clock and timed functions for process optimization. • Increased productivity and faster payback times with multiple setups. • Built-in counters for additional energy savings and preventive maintenance.
Water handling	Compressors, pump stations	<ul style="list-style-type: none"> • Additional energy savings with energy optimizer function. • Adjustable accel/decel ramps to improve pump control. • Minimized downtime with robust and reliable design. • Built-in PFC macro to control up to four pumps or compressors, allowing flow optimization. • ABB's extensive product and service offering for comprehensive process optimization.
Agriculture	Fans, irrigators, pumps, sorters	<ul style="list-style-type: none"> • Optimized for cabinet installations with unified height and depth and panel door mounting options. • Timed functions to adjust the process control depending on e.g. the time of the day. • Three relay outputs and PFC feature to control up to four pumps and to optimize output.
Sawmill	Wood drying kilns, conveyors for chips	<ul style="list-style-type: none"> • Safe torque off (SIL 3/PL e) function ensures machine and personnel safety. • Integrated brake chopper to speed up braking and productivity. • Heavy-duty rating and higher starting torque for improved robustness. • Three relay outputs for connecting even four fans without external components. • Turning on and off parallel fans based on the humidity of air (requires an external sensor).
Automotive	Conveyors, fans, pumps	<ul style="list-style-type: none"> • Increased productivity and faster payback times with multiple setups. • Enhanced quality of end products with smooth control of the motor and process. • Safe torque off (SIL 3/PL e) function ensures machine and personnel safety. • Common fieldbus networks supported. • The robust design of the drive reduces mechanical stress on process line equipment, lowering maintenance costs and ensuring high production quality.

How to select a drive

The standard delivery includes all the built-in features, the assistant control panel and the I/O module. The control panel and the I/O module can be replaced with other panels and fieldbus options. The following instructions show you how to order the right drive for your application.

Determine the voltage range and the overload in your application. Typically, fans and pumps can be dimensioned according to light-duty use, while for applications requiring higher torque, it is recommended to dimension according to heavy-duty use.

1

2

Select your drive's order code from the rating table based on your motor's power rating according to light-duty or heavy-duty use.

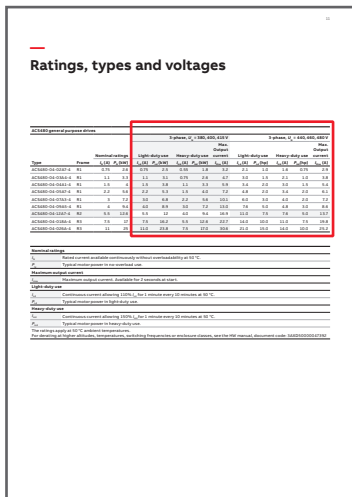

Page 11

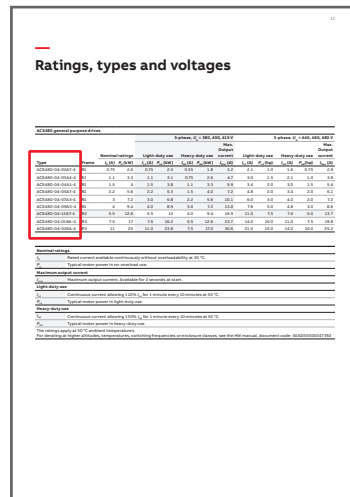

Page 11

Choose your panels and options (on page 15) and add the codes to the drive's order code if needed. Remember to use a "+" mark before each option code.

3

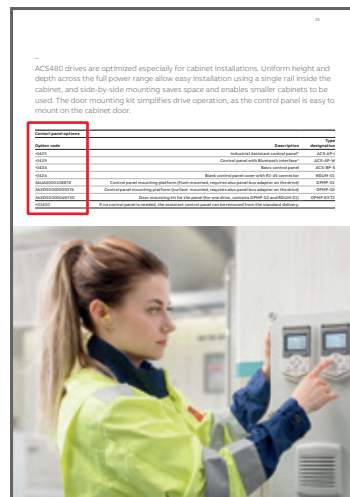

Page 15

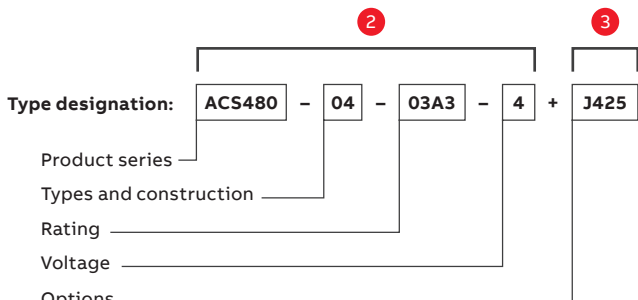

Ratings, types and voltages

ACS480 general purpose drives														
		3-phase, $U_N = 380, 400, 415$ V							3-phase, $U_N = 440, 460, 480$ V					
Type	Frame	Nominal ratings		Light-duty use		Heavy-duty use		Max. Output current I_{Max} (A)	Light-duty use		Heavy-duty use		Max. Output current I_{Max} (A)	
		I_N (A)	P_N (kW)	I_{Ld} (A)	P_{Ld} (kW)	I_{Hd} (A)	P_{Hd} (kW)		I_{Ld} (A)	P_{Ld} (hp)	I_{Hd} (A)	P_{Hd} (hp)		
ACS480-04-02A7-4	R1	2.6	0.75	2.5	0.75	1.8	0.55	3.2	2.1	1.0	1.6	0.75	2.9	
ACS480-04-03A4-4	R1	3.3	1.1	3.1	1.1	2.6	0.75	4.7	3.0	1.5	2.1	1.0	3.8	
ACS480-04-04A1-4	R1	4	1.5	3.8	1.5	3.3	1.1	5.9	3.4	2.0	3.0	1.5	5.4	
ACS480-04-05A7-4	R1	5.6	2.2	5.3	2.2	4.0	1.5	7.2	4.8	2.0	3.4	2.0	6.1	
ACS480-04-07A3-4	R1	7.2	3	6.8	3.0	5.6	2.2	10.1	6.0	3.0	4.0	2.0	7.2	
ACS480-04-09A5-4	R1	9.4	4	8.9	4.0	7.2	3.0	13.0	7.6	5.0	4.8	3.0	8.6	
ACS480-04-12A7-4	R2	12.6	5.5	12	5.5	9.4	4.0	16.9	11.0	7.5	7.6	5.0	13.7	
ACS480-04-018A-4	R3	17	7.5	16.2	7.5	12.6	5.5	22.7	14.0	10.0	11.0	7.5	19.8	
ACS480-04-026A-4	R3	25	11	23.8	11.0	17.0	7.5	30.6	21.0	15.0	14.0	10.0	25.2	

Nominal ratings

I_N Rated current available continuously without overloadability at 50 °C.

P_N Typical motor power in no-overload use.

Light-duty use

I_{Ld} Continuous current allowing 110% I_{Ld} for 1 minute every 10 minutes at 50 °C.

P_{Ld} Typical motor power in light-duty use.

Heavy-duty use

I_{Hd} Continuous current allowing 150% I_{Hd} for 1 minute every 10 minutes at 50 °C.

P_{Hd} Typical motor power in heavy-duty use.

Maximum output current

I_{max} Maximum output current. Available for 2 seconds at start.

The ratings apply at 50 °C ambient temperatures.

For derating at higher altitudes, temperatures, switching frequencies or enclosure classes, see the HW manual, document code: 3AXD50000047392

Technical data

Mains connection	
Voltage and power range	3-phase, 380 to 480 V, +10%/-15% from 0.75 up to 11 kW
Frequency	from 48 to 63 Hz
Motor connection	
Voltage	0 to U_N , 3-phase
Frequency	0 to 599 Hz
Motor control	Scalar and vector control
Speed control	Static accuracy: 20% of motor nominal slip Dynamic accuracy: 1% seconds with 100% torque step
Product compliance	
	CE
	Low Voltage Directive 2014/34/EU, EN 61800-5-1: 2007
	Machinery Directive 2006/42/EC, EN 61800-5-2: 2007
	EMC Directive 2014/30/EU, EN 61800-3: 2004 + A1: 2012
	RoHS directive 2011/65/EU
	Quality assurance system ISO 9001
	Environmental system ISO 14001
	Waste electrical and electronic equipment directive (WEEE) 2002/96/EC
	RoHS directive 2011/65/EU
	TÜV certification for functional safety pending
EMC according to EN 61800-3: 2004 + A1: 2012	
	ACS480 cabinet-mounted drive with built-in C2 category filter as standard

Environmental limits	
Ambient temperature	
Transport	-40 to +70 °C
Storage	-40 to +70 °C
Operation area	-10 to +50 °C no derating required, no frost allowed +50 °C - +60 °C with derating
Cooling method	
Air-cooled	Dry clean air
Altitude	
0 to 1,000 m	Without derating
1,000 to 2,000 m	With derating of 1%/100 m
Above 2,000 m	For information on the correct derating values, contact your local ABB representative.
Relative humidity	5 to 95%, no condensation allowed
Degree of protection	IP20
Functional safety	Safe torque off (STO according EN 61800-5-2) IEC 61508 ed2: SIL 3. IEC 61511: SIL 3. IEC 62061: SIL CL 3. EN ISO 13849-1: PL e
Contamination levels	No conductive dust allowed
Storage	IEC 60721-3-1. Class 1C2 (chemical gases). Class 1S2 (solid particles)*
Transportation	IEC 60721-3-2. Class 2C2 (chemical gases). Class 2S2 (solid particles)*
Operation	IEC 60721-3-3. Class 3C2 (chemical gases). Class 3S2 (solid particles)*

*C = chemically active substances
S = mechanically active substances

Dimensions

ACS480 IP20								
Frames	Height		Width		Depth		Weight	
	(mm)	in	mm	in	mm	in	kg	lb
R1	223.00	8.78	73.00	2.87	207.2	8.16	1.8	3.9
R2	223.00	8.78	96.70	3.81	207.2	8.16	2.4	5.2
R3	223.00	8.78	171.50	6.75	207.2	8.16	3.6	7.8

* Front height of the drive with clamp



Easiness on a whole new level

Enjoy the simplicity effortlessly with the assistant control panel's intuitive user interface, assistants and ready-made macros. The panel guides you through commissioning without a need to know any drive parameters and helps in unclear situations.



Assistant control panel, ACS-AP-S

Set up the drive, fine-tune motor control and monitor values that matter using the assistant control panel, delivered as standard with all ACS480 drives. The assistant control panel can also be used with the ACS580 and the ACS380.

Commission without a hassle

Select language, set time and date, name the drive, enter motor values, test rotating the motor.

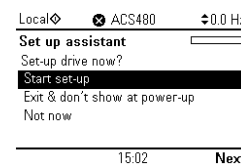
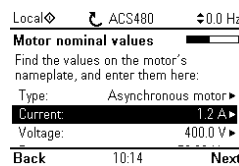
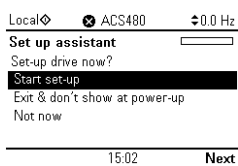

Primary settings

Select ready-made macros such as ABB standard, PFC, Panel PID, 3-wire, perform ID-run, fine-tune settings related to e.g. ramps, limits, PIDs, fieldbuses, reset to defaults.

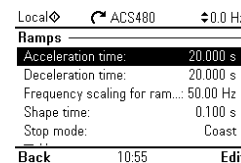
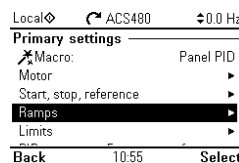
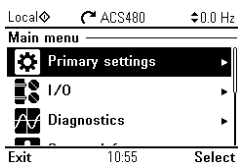

Home view displays

Effortlessly monitor the values that are the most important to you. You can select values for monitoring from a ready-made list or choose user-defined parameters.

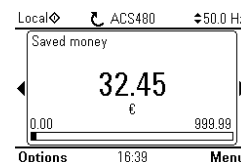
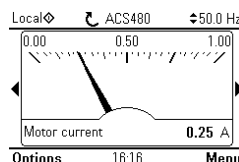
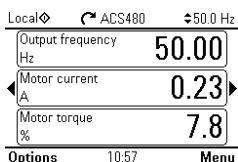

Help button

The help button provides more information about your selection and it can be pressed in any view.

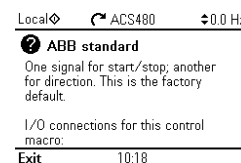
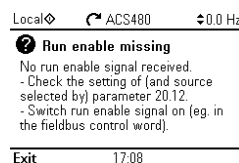
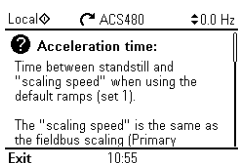

Control panel options and mounting kits

The standard delivery of the ACS480 includes the assistant control panel, but it can be replaced by other panels using the +J codes.



Bluetooth control panel, ACS-AP-W*

The optional Bluetooth panel enables connection with the Drivetune mobile app. The app is available for free from Google Play and the Apple App store. Together with the Drivetune app and the Bluetooth panel, users can, for example, commission and monitor the drive remotely.



Control panel mounting platform, DPMP-01

This mounting platform is for flush mountings. This requires also RDUM-01 (blank control panel with the RJ-45 connector) and a control panel (assistant, basic, Bluetooth or industrial).



Basic control panel, ACS-BP-S

The icon-based control panel supports users with parameter backup, settings and fault tracking in basic operation.



Control panel mounting platform, DPMP-02

This mounting platform is for surface mountings. This requires also RDUM-01 (blank control panel with the RJ-45 connector) and a control panel (assistant, basic, Bluetooth or industrial).



Blank control panel cover with RJ-45 connector, RDUM-01

The RDUM-01 panel is used in cabinet installations to connect the assistant control panel, basic control panel, or Bluetooth control panel on the cabinet door to the drive with the RJ-45 cable.



Door mounting kit, DPMP-EXT2

The door mounting kit is ideal for cabinet installations. A kit for one drive includes one DPMP-02 and one RDUM-01 (blank control panel cover with RJ-45 connector). If a different control panel than the assistant panel is desired for cabinet door installation, it needs to be ordered separately.



Industrial control panel, ACS-AP-I*

The industrial control panel is compatible with all ABB drives, making it simple to use a single panel with different products.

* Also compatible with other ABB all-compatible drives: ACS380, ACS580, and ACS880 drives.

ACS480 drives are optimized especially for cabinet installations. Uniform height and depth across the full power range allow easy installation using a single rail inside the cabinet, and side-by-side mounting saves space and enables smaller cabinets to be used. The door mounting kit simplifies drive operation, as the control panel is easy to mount on the cabinet door.

Control panel options		
Loose option code/ plus code	Description	Type designation
3AUA0000064884	Assistant control panel as standard	ACS-AP-S
3AUA0000088311/+J425	Industrial Assistant control panel*	ACS-AP-I
3AXD50000025965/+J429	Control panel with Bluetooth interface*	ACS-AP-W
3AXD50000028828/+J404	Basic control panel	ACS-BP-S
3AXD50000040850/+J424	Blank control panel cover with RJ-45 connector	RDUM-01
3AUA0000108878	Control panel mounting platform (flush mounted, requires also panel bus adapter on the drive)	DPMP-01
3AXD50000009374	Control panel mounting platform (surface mounted, requires also panel bus adapter on the drive)	DPMP-02
3AXD50000048730	Door mounting kit for the panel (for one drive, contains DPMP-02 and RDUM-01)	DPMP-EXT2
+0J400	If no control panel is needed, the assistant control panel can be removed from the standard delivery.	



Standard interface and extensions for plug-in connectivity

ACS480 drives offer a wide range of standard interfaces. In addition, the drive has one slot for either an I/O module or a fieldbus module.



Default factory I/O connection diagram

Terminal	Meaning	Default macro connections	
Reference voltage and analog inputs and outputs.			
1	SCR	Signal cable shield (screen)	
2	AI1	Output frequency/speed reference: 0...10 V ¹⁾	
3	AGND	Analog input circuit common	
4	+10 V	Reference voltage 10 V DC	
5	AI2	Not configured	
6	AGND	Analog input circuit common	
7	AO1	Output frequency: 0...20 mA	
8	AO2	Output current: 0...20 mA	
9	AGND	Analog output circuit common	
Aux. voltage output and programmable digital inputs			
10	+24 V	Auxiliary voltage output +24 V DC, max. 250 mA	
11	DGND	Auxiliary voltage output common	
12	DCOM	Digital input common for all	
13	DI1	Stop (0)/Start (1)	
14	DI2	Forward (0)/Reverse (1)	
15	DI3	Constant frequency/speed selection	
16	DI4	Constant frequency/speed selection	
17	DI5	Ramp set 1 (0)/Ramp set 2 (1)	
18	DI6	Not configured	
Relay outputs			
19	RO1C		Ready
20	RO1A		250 V AC/30 V DC
21	RO1B		2 A
22	RO2C		Running
23	RO2A		250 V AC/30 V DC
24	RO2B		2 A
25	RO3C		Fault (-1)
26	RO3A		250 V AC/30 V DC
27	RO3B		2 A
EIA-485 Modbus RTU			
29	B+		Embedded Modbus RTU (EIA-485)
30	A-		
31	DGND		
S100	TERM&BIAS	Serial data link termination switch	
Safe torque off			
34	SGND		Safe torque off. Factory connection. Both circuits must be closed for the drive to start. See chapter The Safe torque off function in the Hardware manual of the drive.
35	IN1		
36	IN2		
37	OUT1		
42	+24 V		
43	DGND		
44	DCOM		

The standard delivery of the ACS480 includes the I/O module. If a fieldbus adapter is needed instead, it should be ordered with a corresponding plus code.

Options and tools

The standard delivery includes the I/O module, but it can be replaced by a fieldbus adapter. In addition, the ACS480 supports various options that further simplify commissioning and operation of the drive.



Fieldbus adapter modules

The ACS480 general purpose drives are compatible with most common fieldbus protocols. Fieldbus communication reduces wiring costs when compared to traditional hardwired input/output connections.



Base unit

The ACS80 comes as standard with the I/O module that can be replaced with a fieldbus adapter. If neither the I/O module nor a fieldbus is needed, the drive can be also orderd as a base unit.



Remote monitoring

With a built-in web server and stand-alone datalogger NETA-21 module enables worldwide and secure access to drives.



Safe configuration for unpowered drives

The CCA-01 cold configuration adapter provides a serial communication interface for unpowered ACS480 drives. With the adapter, safe isolation of both serial communication and control board power supply is possible. The power supply is taken from a PC USB port.



PC tools

The Drive composer PC tool offers fast and harmonized setup, commissioning and monitoring. The free version of the tool provides startup and maintenance capabilities and gathers all drive information, such as parameter loggers, faults, and backups into a support diagnostics file. Drive composer pro provides additional features such as custom parameter windows, graphical control diagrams of the drive's configuration, and improved monitoring and diagnostics.

Fieldbus adapters		
Loose option code/ plus code	Fieldbus protocol	Adapter
68469325/+K454	PROFIBUS DP, DPV0/DPV1	FPBA-01
3AUA0000089107/+K473	EtherNet/IP™, Modbus TCP, PROFINET IO	FENA-11
3AUA0000089109/+K475	Two port EtherNet/IP™, Modbus TCP, PROFINET IO	FENA-21

Remove the I/O module

+0L540	Removes the I/O module (RIIO-01) and Modbus RTU interface from the delivery leaving only the base unit I/O connections (2 x digital input, 1 x relay output STO)
--------	--

Remote monitoring, NETA-21

Ordering code	Description	Type designation
3AUA0000094517	2 x panel bus interface 2 x 32 = max. 64 drives 2 x Ethernet interface SD memory card USB port for WLAN/3G	NETA-21

Cold configurator adapter

Ordering code	Description	Type designation
3AXD50000019865	Cold configurator adapter, packed kit	CCA-01

Drive composer

Link/ordering codes	Description	Type designation
new.abb.com/drives/software-tools/drive-composer	Link to download Drive composer entry	
9AKK105408A3415	Drive composer entry PC tool (document)	
3AUA0000108087	Drive composer pro PC tool (single user licence)	DCPT-01
3AUA0000145150	Drive composer pro PC tool (10 users licence)	DCPT-01
3AUA0000145151	Drive composer pro PC tool (20 users licence)	DCPT-01

Cooling and fuses

Cooling

ACS480 drives are fitted with variable-speed cooling air fans. The cooling air must be free from corrosive materials and not exceed the maximum ambient temperature of 50 °C (60 °C with derating). The speed-controlled fans cool the drive only when needed, which reduces overall noise level and energy consumption.

Fuse connections

Standard fuses can be used with ABB general purpose drives. For input fuses, see the table below.

Cooling air flow and recommended input protection fuses for 380 to 415 V units

Type designation	Frame size	Cooling air flow 380 to 415 V units					Recommended input protection fuses for 380 to 415 V units***					
		Heat dissipation*		Air flow		Max. noise level**	IEC fuses		IEC fuses		UL fuses	
		W	BTU/ Hr	m ³ /h	ft ³ / min	dB(A)	A	Fuse type	A	Fuse type	A	Fuse type
ACS480-04-02A7-4	R1	60	205	57	33	63	6	gG	25	gR	6	UL class T
ACS480-04-03A4-4	R1	67	229	57	33	63	6	gG	25	gR	6	UL class T
ACS480-04-04A1-4	R1	75	256	57	33	63	10	gG	32	gR	10	UL class T
ACS480-04-05A7-4	R1	93	317	57	33	63	10	gG	32	gR	10	UL class T
ACS480-04-07A3-4	R1	112	383	57	33	63	16	gG	40	gR	20	UL class T
ACS480-04-09A5-4	R1	139	476	57	33	63	16	gG	40	gR	20	UL class T
ACS480-04-12A7-4	R2	183	624	63	37	59	25	gG	50	gR	25	UL class T
ACS480-04-018A-4	R3	232	793	128	75	66	32	gG	63	gR	35	UL class T
ACS480-04-026A-4	R3	346	1182	128	75	66	50	gG	80	gR	50	UL class T

* Heat dissipation value is a reference for cabinet thermal design.

** The maximum noise level at full fan speed. When the drive is not operating at full load and at maximum ambient temperature the noise level is lower.

*** For detailed fuse sizes and types. please see the ACS480 HW manual, document code: 3AXD50000047392

Input chokes, du/dt filters, brake choppers and resistors

Input and du/dt filters

External input chokes can be used with the ACS480 drives if there is a need to optimize the line-side harmonics. du/dt filtering, on the other hand, suppresses inverter output voltage spikes and rapid voltage changes that stress motor insulation. Additionally, du/dt filtering reduces capacitive leakage currents and high-frequency

emissions from the motor cable as well as high-frequency losses and bearing currents in the motor. The need for du/dt filtering depends on the motor insulation. For information on the construction of the motor insulation, consult the manufacturer. More information on the du/dt filters can be found in the ACS480 hardware manual.

External input chokes, du/dt filters, and C1 filters for 380 to 480 V units				
ACS480 400 V	Frame	Input choke, max. ambient temp. 40 °C	du/dt filter type, max. ambient temp. 40 °C	C1 filter
ACS480-04-02A7-4	R1	CHK-01	ACS-CHK-B3	Schaffner FN 3268-7-44
ACS480-04-03A4-4	R1	CHK-01	ACS-CHK-B3	Schaffner FN 3268-7-44
ACS480-04-04A1-4	R1	CHK-02	ACS-CHK-C3	Schaffner FN 3268-7-44
ACS480-04-05A7-4	R1	CHK-02	ACS-CHK-C3	Schaffner FN 3268-7-44
ACS480-04-07A3-4	R1	CHK-02	NOCH0016-6x	Schaffner FN 3268-16-44
ACS480-04-09A5-4	R1	CHK-03	NOCH0016-6x	Schaffner FN 3268-16-44
ACS480-04-12A7-4	R2	CHK-03	NOCH0016-6x	Schaffner FN 3268-16-44
ACS480-04-018A-4	R3	CHK-04	NOCH0030-6x	Schaffner FN 3268-30-33
ACS480-04-026A-4	R3	CHK-04	NOCH0030-6x	Schaffner FN 3268-30-33

Brake chopper and resistor

All ACS480 drives are equipped with a built-in brake chopper. The brake chopper prevents the drive from tripping due to overvoltage while allowing faster braking. Faster braking enables shorter start and stop cycles, and thus productivity can be increased.

To benefit from the brake chopper, an external brake resistor needs to be connected to the chopper. The brake resistor transfers the braking energy into heat.

Brake choppers and brake resistors for 380 to 415 V units						
ACS480	Frame	Internal brake chopper				Example brake resistor(s) Reference resistor types Danotherm
		P_{BRcont} (kW)	P_{BRmax} (kW)	R_{min} (ohm)	R_{max} (ohm)	
ACS480-04-02A7-4	R1	0.6	0.8	98.8	627.8	
ACS480-04-03A4-4	R1	0.8	1.1	98.8	427.5	
ACS480-04-04A1-4	R1	1.1	1.7	98.8	284.7	CBH 360 C T 406 210R or CAR 200 D T 406 210R
ACS480-04-05A7-4	R1	1.5	2.3	98.8	206.4	
ACS480-04-07A3-4	R1	2.2	3.3	52.7	139.1	
ACS480-04-09A5-4	R1	3.0	4.5	52.7	102.0	
ACS480-04-12A7-4	R2	4.0	6.0	31.6	75.7	CBR-V 330 D T 406 78R UL
ACS480-04-018A-4	R3	5.5	8.3	31.6	54.4	
ACS480-04-026A-4	R3	7.5	11.3	22.6	39.0	CBR-V 560 D HT 406 39R UL

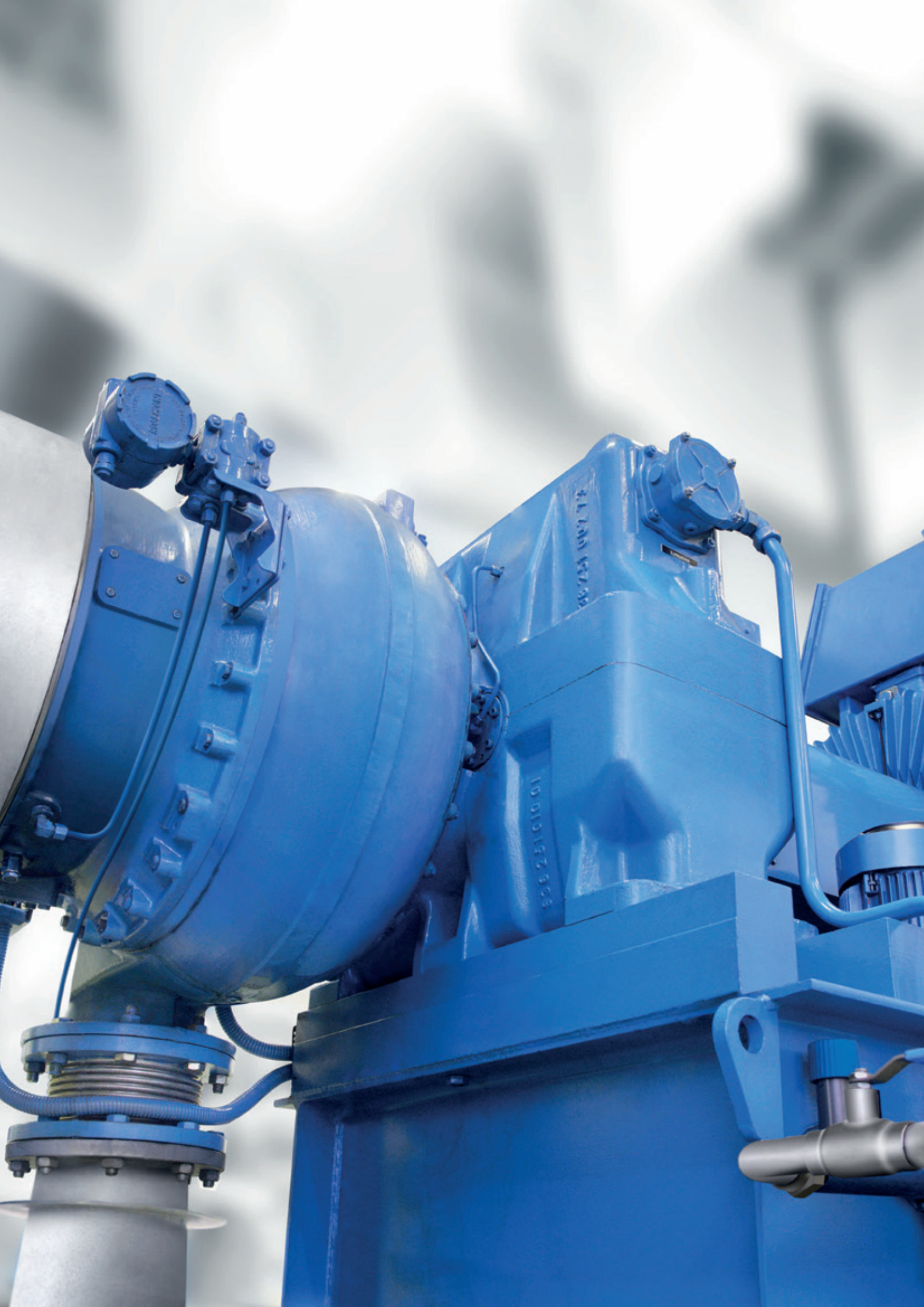

Everything for your application

The ACS480 and ACS580 share the same assistant control panel and operation logic, making it easy to switch between them. The ACS480 offers the basic essentials while the ACS580 equippes users e.g. with a wider power range, higher protection class for wall mounting, and more options.



ACS480

- Optimized for cabinets, IP20
- Power up to 11 kW
- Uniform height and depth across the power range for cabinet installations
- Most common fieldbuses supported as options



ACS580

- Wall mounting, cabinet-built drives, drive modules, flange mounting
- Power up to 500 kW
- IP55 across the full power range
- DC-choke for harmonics mitigation
- PWM controlled mains fan
- More I/O extensions and ATEX options
- Adaptive programming
- Motor cables up to 300 meters

The ACS480 is also compatible with the wide ABB product offering



Programmable Logic Controllers PLCs

The AC500, AC500-eCo, AC500-S and AC500-XC scalable PLC ranges provide solutions for small, medium and high-end applications. Our AC500 PLC platform offers different performance levels and is the ideal choice for high availability, extreme environments, condition monitoring, motion control or safety solutions.



All-compatible drives portfolio

The all-compatible drives share the same architecture; software platform, tools, user interfaces and options. Yet, there is an optimal drive from the smallest water pump to the biggest cement kiln, and everything in the between.



AC motors

ABB's low voltage AC motors are designed to save energy, reduce operating costs and minimize unscheduled downtime. General performance motors ensure convenience, while process performance motors provide a broad set of motors for the process industries and heavy-duty applications.



Automation Builder Engineering suite

ABB Automation Builder is the software for machine builders and system integrators wanting to automate their machines and systems in a unified and efficient way. Automation Builder connects the engineering tools for PLC, safety, control panels, SCADA, drives, motion and robots.



Control panels

CP600-eCo and CP600 HMI control panels offer a wide range of features and functionalities for maximum operability. ABB control panels are distinguished by their robustness and easy usability, providing all the relevant information from production plants and machines at one single touch.



Jokab safety products

ABB Jokab Safety offers an extensive range of innovative products and solutions for machine safety systems. It is represented in standardization organizations for machine safety and works daily with the practical application of safety requirements in combination with production requirements.

Save time, ease troubleshooting and improve drive performance with ABB smartphone apps

Better connectivity and user experience with Drivetune

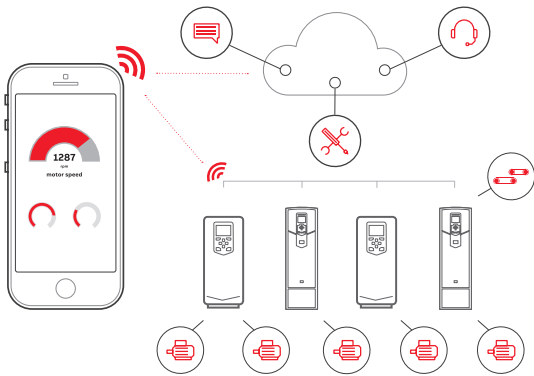

Easy and fast access to product information and support

Manage your drives and the process lines and machines they control



Easy access to cloud-based drive and process information from anywhere via an online connection



Start up, commission and tune your drive and application



Simplified user guidance with instant access to drive status and configuration



Performance optimization via drive troubleshooting features and fast support

Services and support on the go with Drivebase

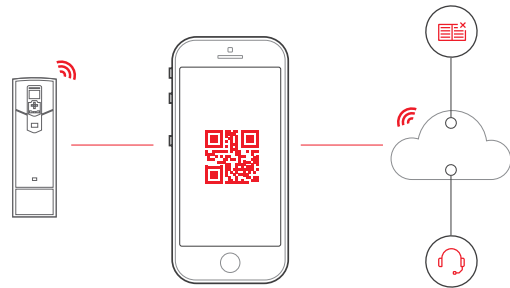

Search for support documents and contacts

Maintain and service all your installed drives on one or multiple sites



Access your product and service information in the cloud from anywhere



Access your drive's diagnostics data



Push notifications for critical product and service updates

Access information anywhere

Download the apps using the QR codes below or directly from the app stores



Drivetune for commissioning and managing drives



Drivebase for ensured reliability and reduced downtime on production sites

A lifetime of peak performance

You're in control of every life cycle phase of your drives. At the heart of drive services is a four-phase product life cycle management model. This model defines the services recommended and available throughout drives lifespan.

Now it's easy for you to see the exact service and maintenance available for your drives.

ABB drives life cycle phases explained:

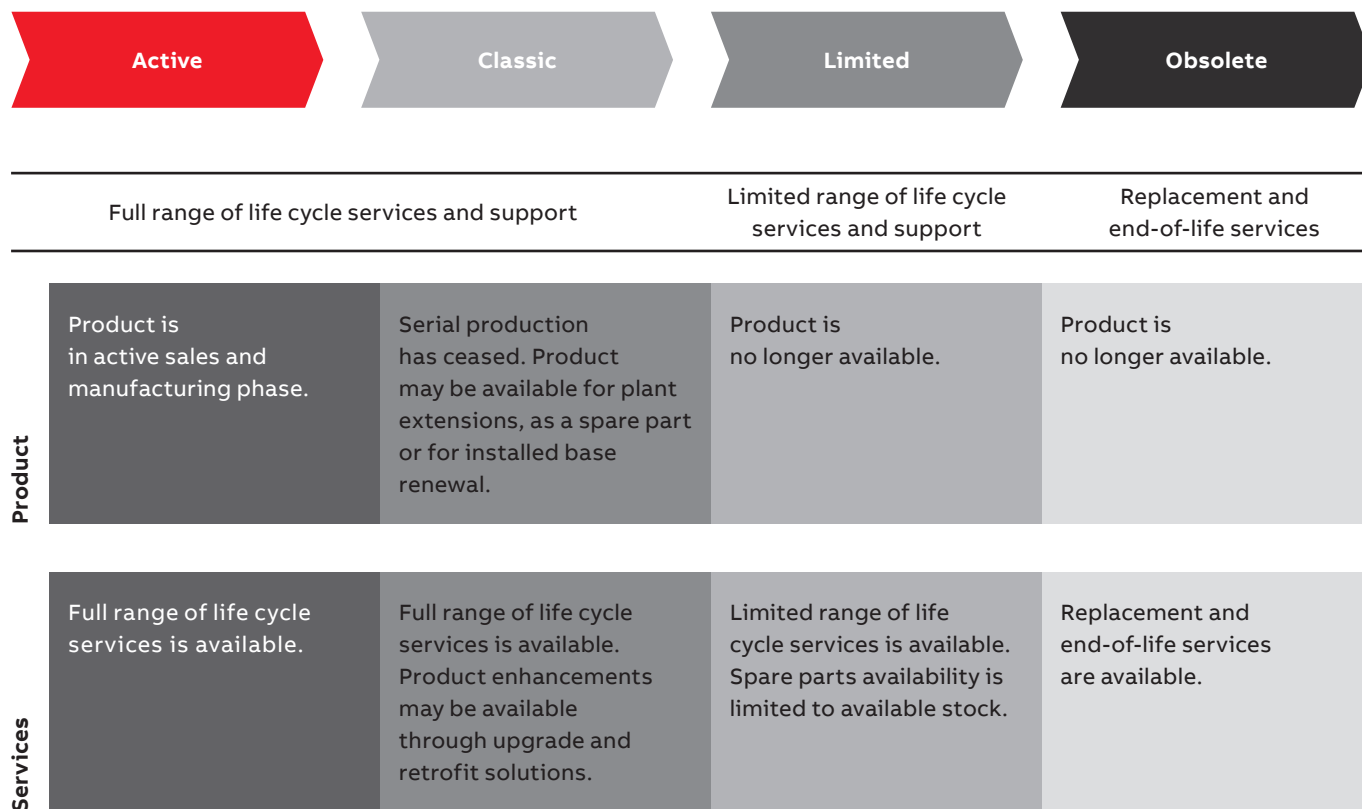

Keeping you informed

We notify you every step of the way using life cycle status statements and announcements.

Your benefit is clear information about your drives' status and precise services available. It helps you plan the preferred service actions ahead of time and make sure that continuous support is always available.

Step 1

Life Cycle Status Announcement

Provides early information about the upcoming life cycle phase change and how it affects the availability of services.

Step 2

Life Cycle Status Statement

Provides information about the drive's current life cycle status, availability of product and services, life cycle plan and recommended actions.

—
For more information, please contact
your local ABB representative or visit

abb.com/ACS480

abb.com/drives

abb.com/drivespartners

abb.com/motors&generators